

DF

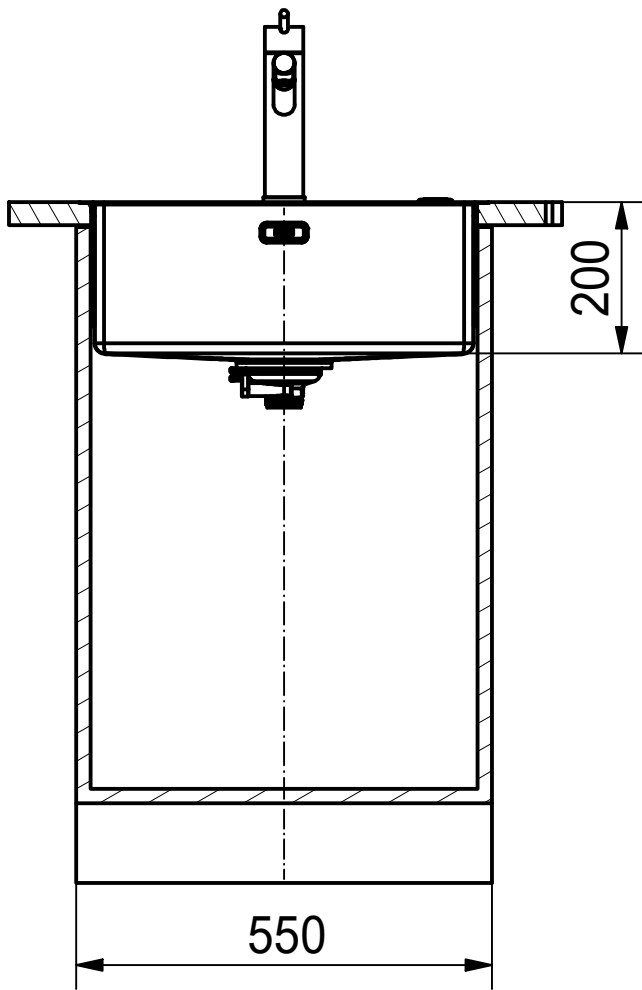

Drawing No.	20198784_02	Revision	A
Drawn Date	16.11.2020		
<small>These drawings and specifications are the property of Franke Technology and Trademark Ltd. and shall not be reproduced, copied or transferred to any third party without the prior written permission of Franke Technology and Trademark Ltd., Hergiswil, Switzerland</small>			



BXM 210/110-50 SI
Installing document

Sheet	Sheets
1	11

DS

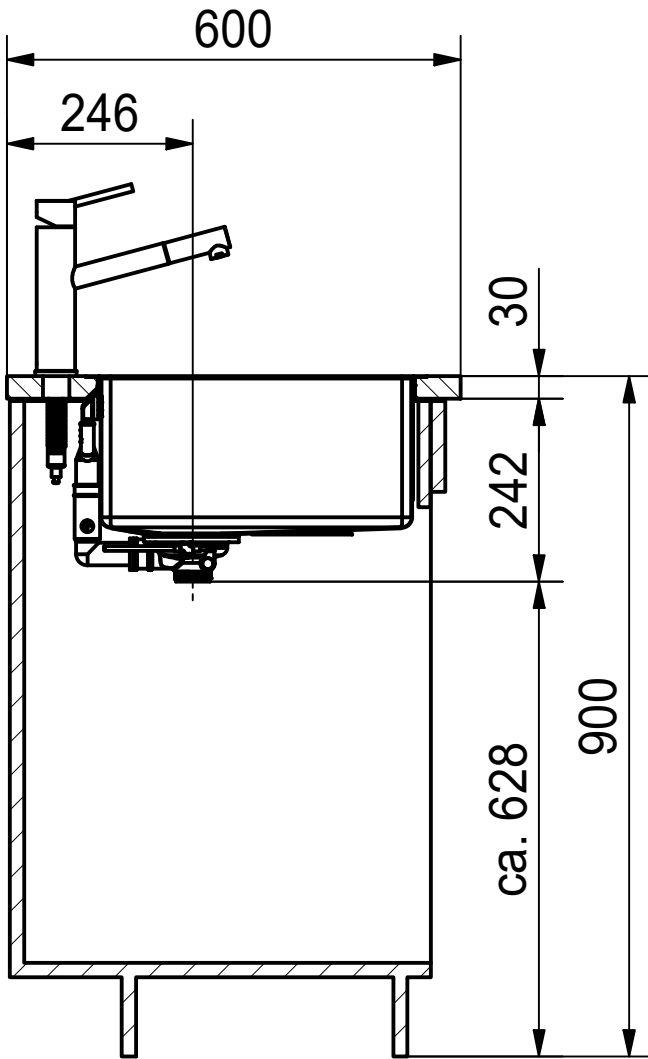

Drawing No.	20198784_02	Revision	A
Drawn Date	16.11.2020		
<small>These drawings and specifications are the property of Franke Technology and Trademark Ltd. and shall not be reproduced, copied or transferred to any third party without the prior written permission of Franke Technology and Trademark Ltd., Hergiswil, Switzerland</small>			



BXM 210/110-50 SI
Installing document

Sheet	Sheets
2	11

CO

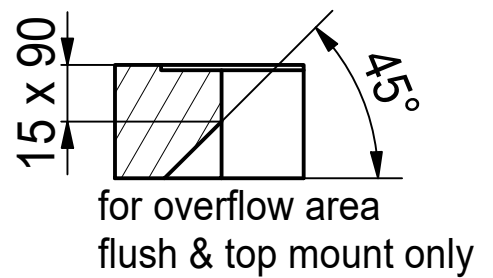
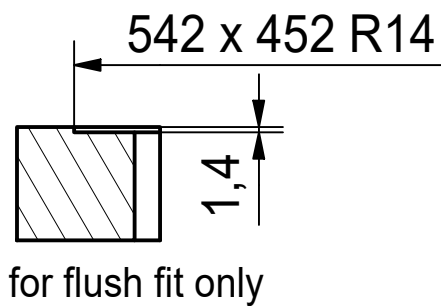
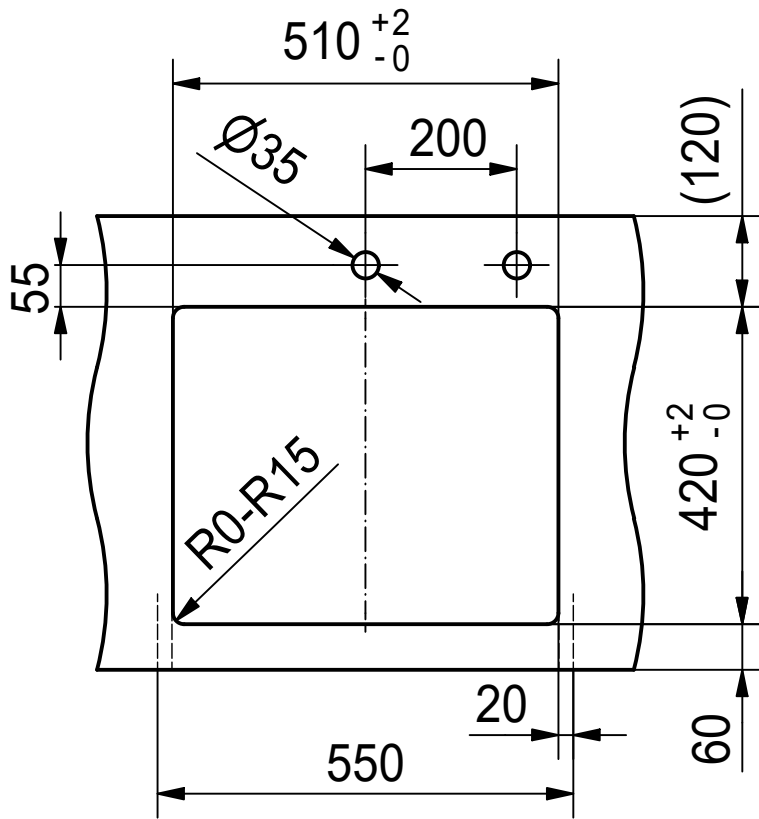

Drawing No.	20198784_02	Revision	A
Drawn Date	16.11.2020		
<small>These drawings and specifications are the property of Franke Technology and Trademark Ltd. and shall not be reproduced, copied or transferred to any third party without the prior written permission of Franke Technology and Trademark Ltd., Hergiswil, Switzerland</small>			



BXM 210/110-50 SI
Installing document

Sheet	Sheets
3	11

CNC



Drawing No.	20198784_02	Revision	A
Drawn Date	16.11.2020		
<small>These drawings and specifications are the property of Franke Technology and Trademark Ltd. and shall not be reproduced, copied or transferred to any third party without the prior written permission of Franke Technology and Trademark Ltd., Hergiswil, Switzerland</small>			



BXM 210/110-50 SI
Installing document

Sheet	Sheets
4	11

DT

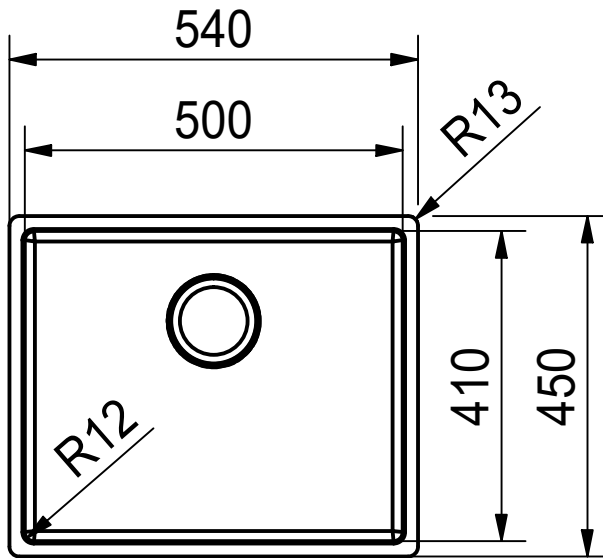

Drawing No.	20198784_02	Revision	A
Drawn Date	16.11.2020		
<small>These drawings and specifications are the property of Franke Technology and Trademark Ltd. and shall not be reproduced, copied or transferred to any third party without the prior written permission of Franke Technology and Trademark Ltd., Hergiswil, Switzerland</small>			



BXM 210/110-50 SI
Installing document

Sheet	Sheets
5	11

ISO

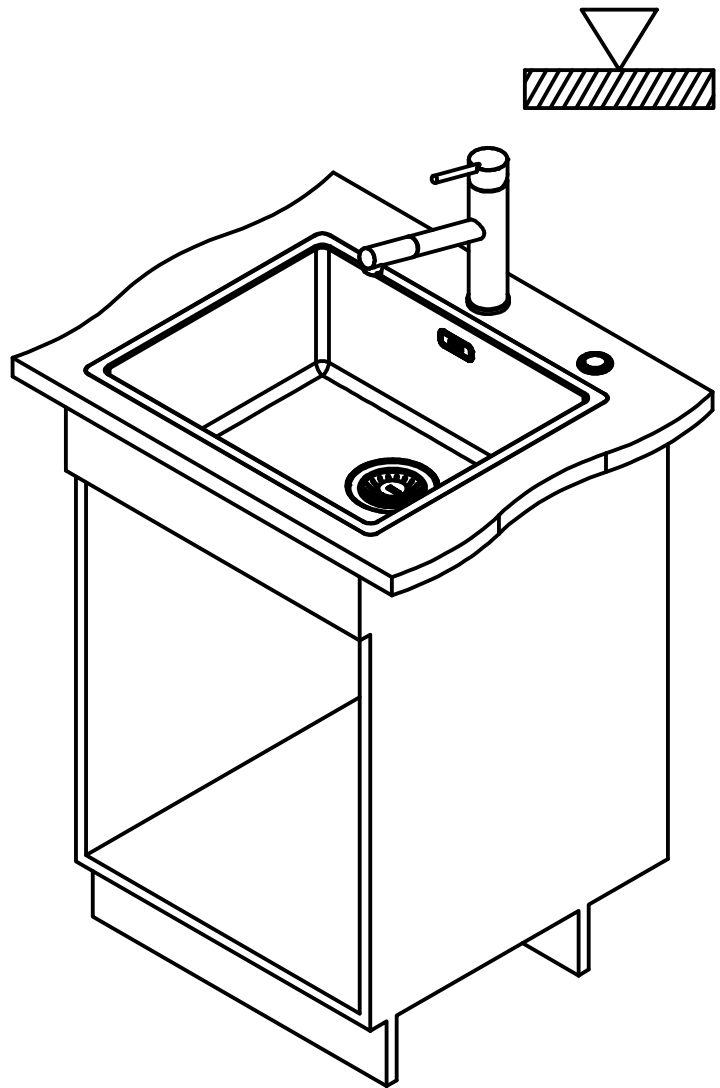

Drawing No.	20198784_02	Revision	A
Drawn Date	16.11.2020		
<small>These drawings and specifications are the property of Franke Technology and Trademark Ltd. and shall not be reproduced, copied or transferred to any third party without the prior written permission of Franke Technology and Trademark Ltd., Hergiswil, Switzerland</small>			



BXM 210/110-50 SI
Installing document

Sheet	Sheets
6	11

DF

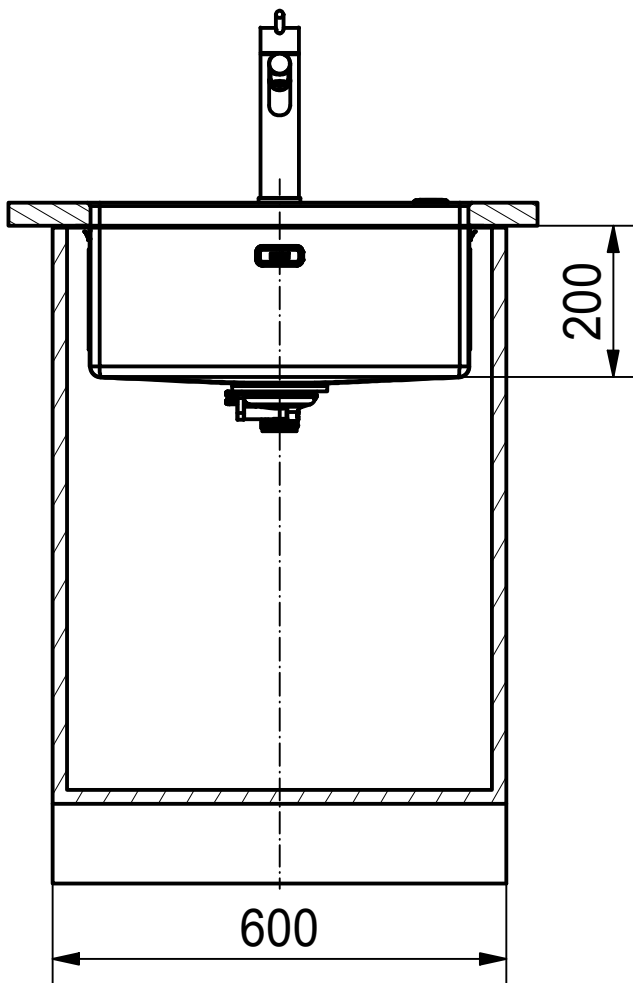

Drawing No.	20198784_02	Revision	A
Drawn Date	16.11.2020		
<small>These drawings and specifications are the property of Franke Technology and Trademark Ltd. and shall not be reproduced, copied or transferred to any third party without the prior written permission of Franke Technology and Trademark Ltd., Hergiswil, Switzerland</small>			



BXM 210/110-50 SI
Installing document

Sheet	Sheets
7	11

DS

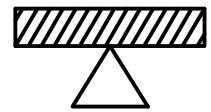
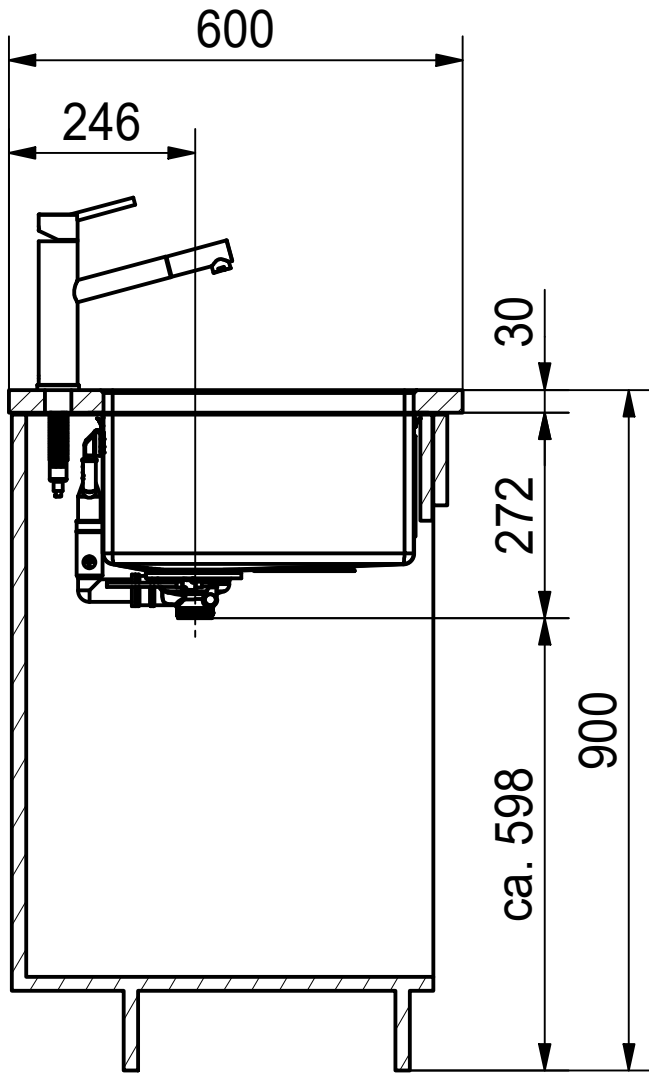

Drawing No.	20198784_02	Revision	A
Drawn Date	16.11.2020		
<small>These drawings and specifications are the property of Franke Technology and Trademark Ltd. and shall not be reproduced, copied or transferred to any third party without the prior written permission of Franke Technology and Trademark Ltd., Hergiswil, Switzerland</small>			



BXM 210/110-50 SI
Installing document

Sheet	Sheets
8	11

CO

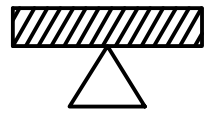
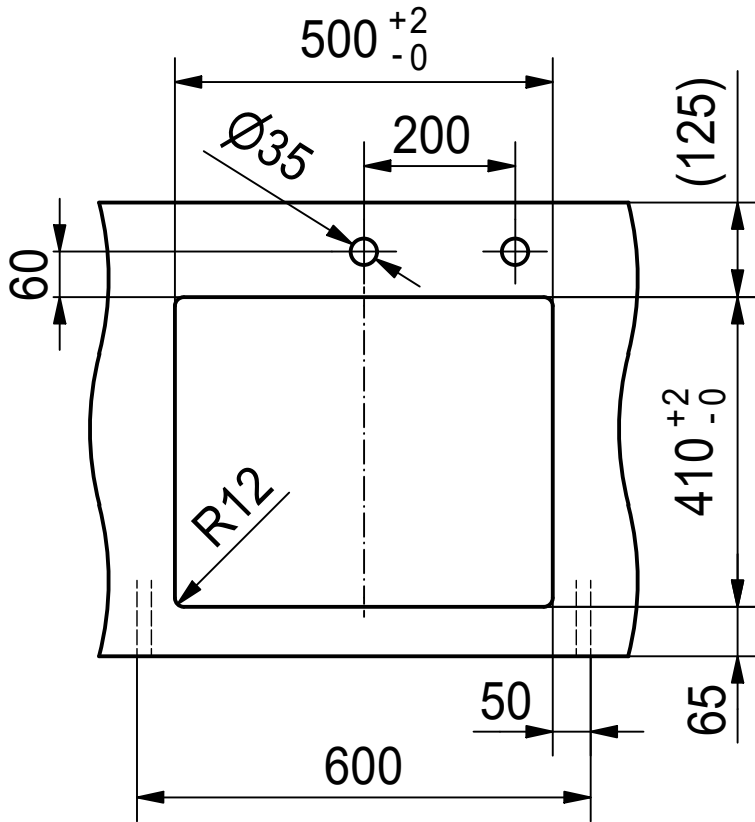

Drawing No.	20198784_02	Revision	A
Drawn Date	16.11.2020		
<small>These drawings and specifications are the property of Franke Technology and Trademark Ltd. and shall not be reproduced, copied or transferred to any third party without the prior written permission of Franke Technology and Trademark Ltd., Hergiswil, Switzerland</small>			



BXM 210/110-50 SI
Installing document

Sheet	Sheets
9	11

CNC

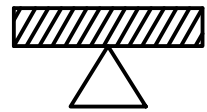

Drawing No.	20198784_02	Revision	A
Drawn Date	16.11.2020		
<small>These drawings and specifications are the property of Franke Technology and Trademark Ltd. and shall not be reproduced, copied or transferred to any third party without the prior written permission of Franke Technology and Trademark Ltd., Hergiswil, Switzerland</small>			



BXM 210/110-50 SI
Installing document

Sheet	Sheets
10	11

ISO

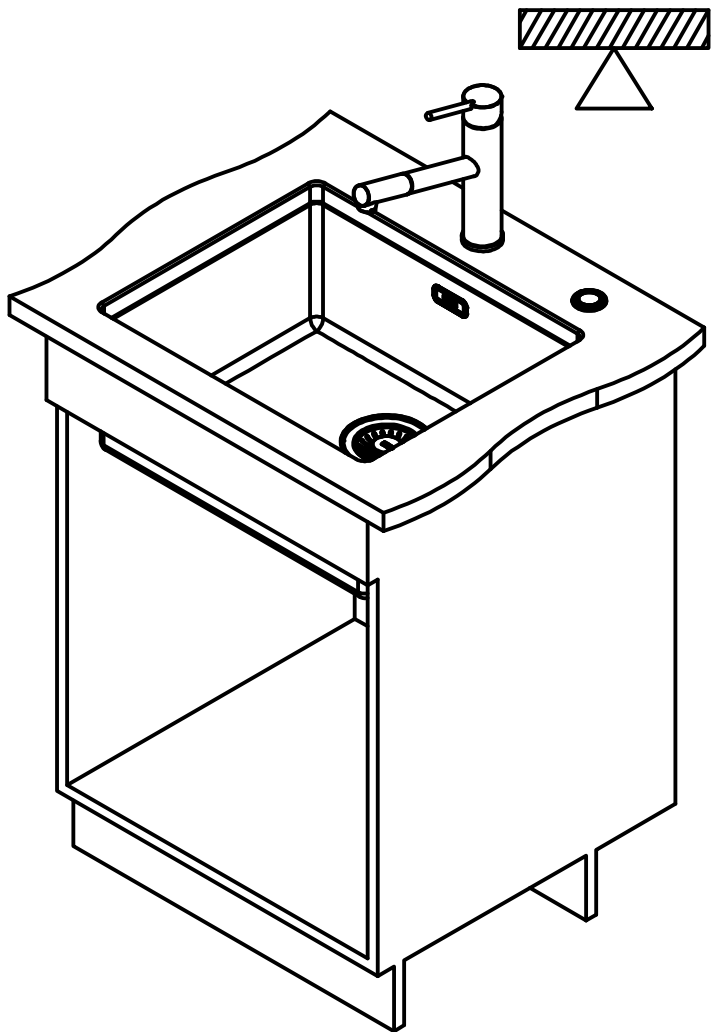

Drawing No.	20198784_02	Revision	A
Drawn Date	16.11.2020		
<small>These drawings and specifications are the property of Franke Technology and Trademark Ltd. and shall not be reproduced, copied or transferred to any third party without the prior written permission of Franke Technology and Trademark Ltd., Hergiswil, Switzerland</small>			



BXM 210/110-50 SI
Installing document

Sheet	Sheets
11	11